

# START-SET: GÜTERZUG BR 80 + 2 SCHÜTTGUTWAGEN #37100

DB BR 80 Ore Train Starter Set · Coffret de départ train de marchandises · Startset goederentrein

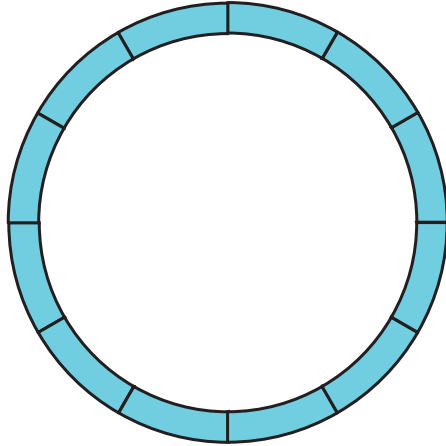

- 1 x Damplokomotive BR 80
- 2 x Schüttgutwagen
- 12 x 35211 R1 (Bogen 600 mm)
- 1 x 35270 Anschlussklemme
- 1 x 35285 Verbindungsclip (14 St.)
- 1 x Fahrregler
- 1 x Transformator

- 1 x Loco vapeur BR 80
- 2 x Wagons silos
- 12 x 35211 Rail courbes R1, r = 600 mm
- 1 x 35270 Fiches des connexion
- 1 x 35285 Clips de rail (14 ps.)
- 1 x Régulateur de vitesse
- 1 x Transformateur

- 1 x Steam Locomotive BR 80
- 2 x Ore Cars
- 12 x 35211 Curved Track R1, r = 600 mm
- 1 x 35270 Power Clamps
- 1 x 35285 Track Clips (14 pcs.)
- 1 x Speed control
- 1 x Transformer

- 1 x Locomotief BR 80
- 2 x Zelflossers
- 12 x 35211 Gebogen railstuk R1, r = 600 mm
- 1 x 35270 Aansluitclips
- 1 x 35285 Railverbindingsclip (14 stuks)
- 1 x Snelheidsregelaar
- 1 x Netadapter

Empfohlene Brettgröße  
Recommended area of layout  
Surface minimale de montage  
Minimale opbouwoppervlakte:  
ca. 150 x 150 cm

Grundfläche  
ground area  
Surface utilisée  
Grondoppervlakte:  
ca. 130 x 130 cm



0-24 V



Technische und farbliche Änderungen vorbehalten. Maße und Abbildungen sind freibleibend. Alle Angaben erfolgen ohne Gewähr.  
All information subject to change without notice.  
Informations susceptibles de modification.

Wijzigingen in kleurstelling, technische gegevens, maten en afbeeldingen zijn onder voorbehoud.  
37100-90-7016

# MONTAGEANLEITUNG BR 80

Service instructions · Manuel d'utilisation · Gebruiksaanwijzing

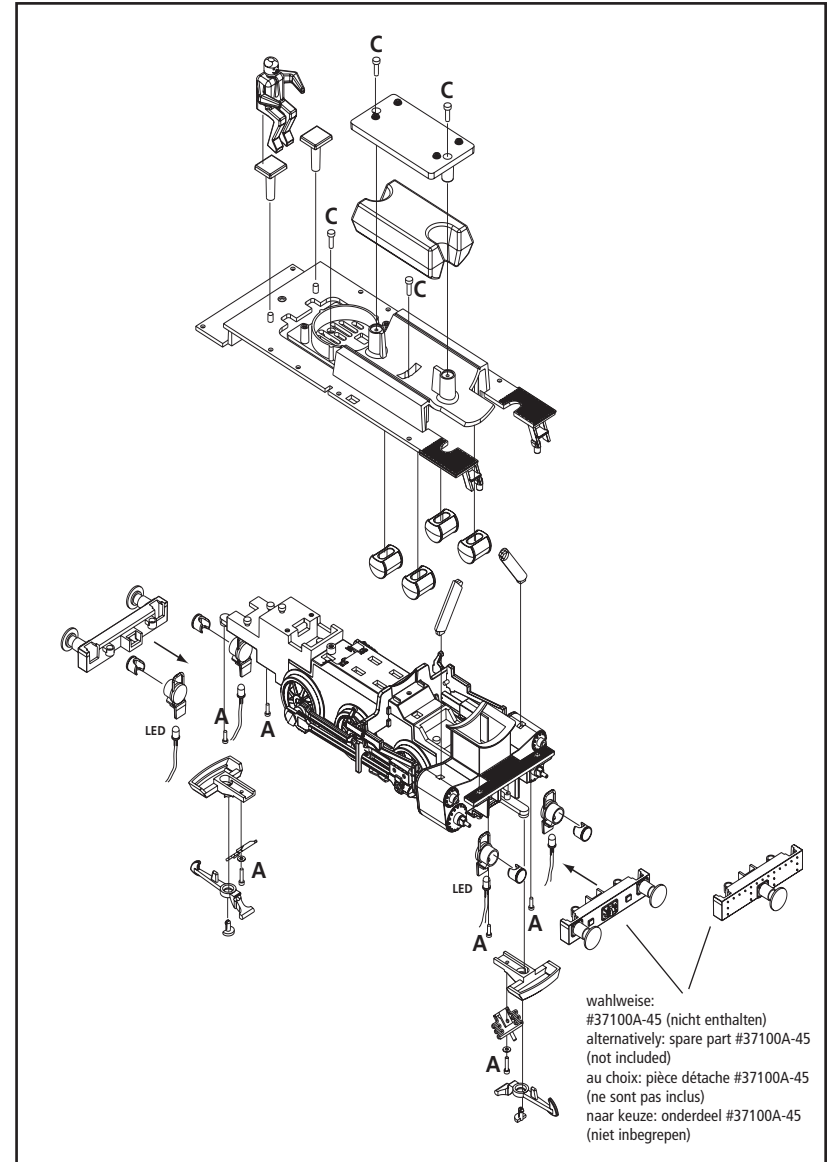
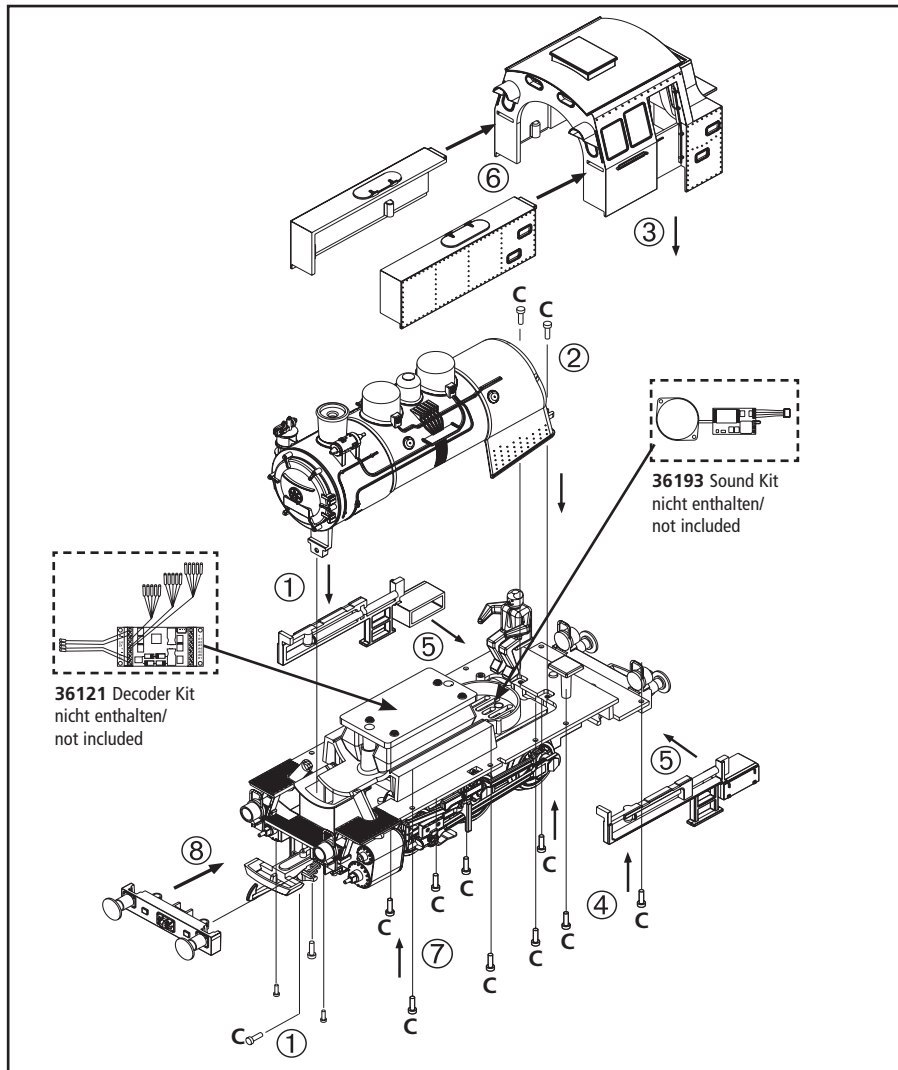

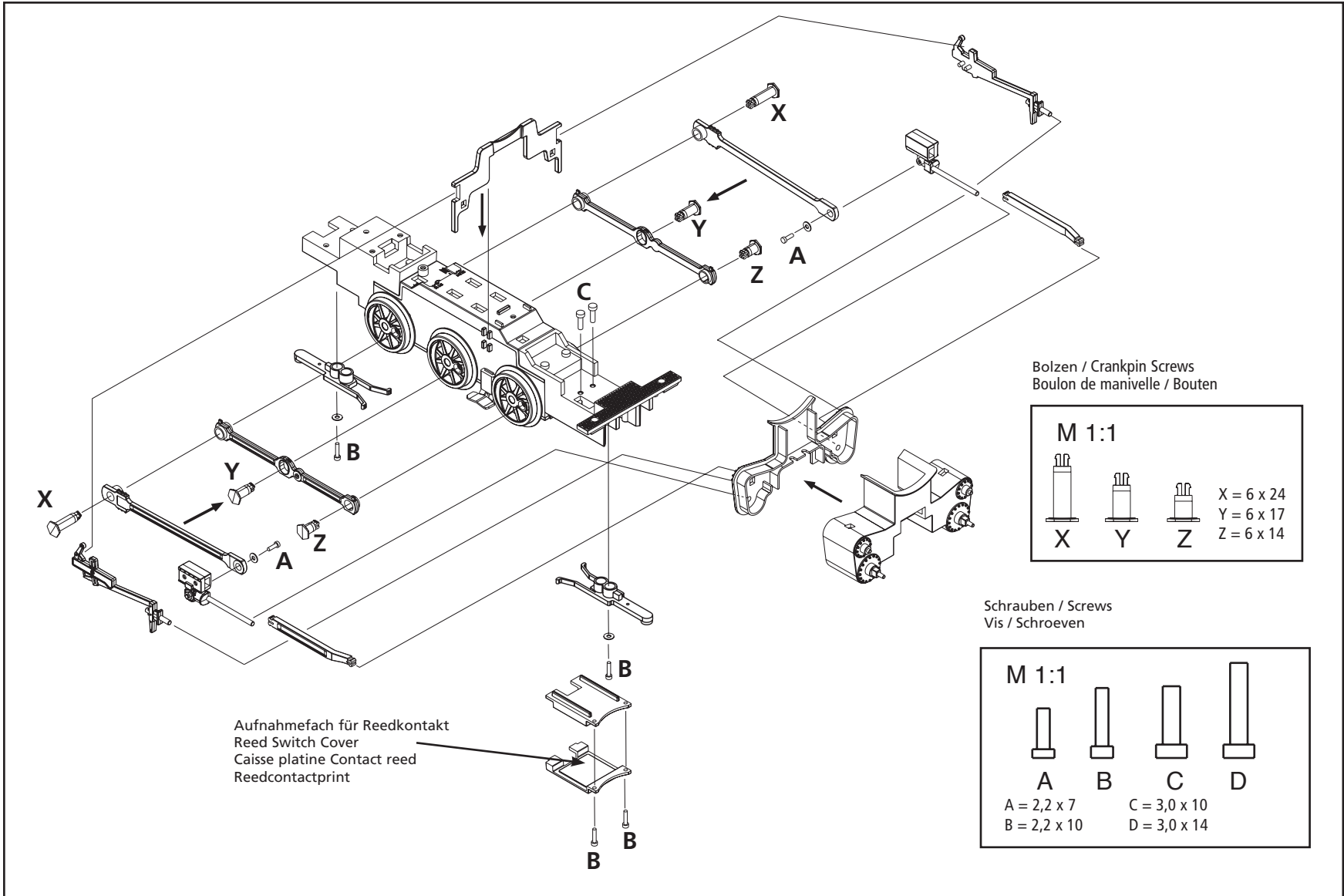

Bolzen / Crankpin Screws  
 Boulon de manivelle / Bouten

**M 1:1**

			X = 6 x 24
			Y = 6 x 17
			Z = 6 x 14

Schrauben / Screws  
 Vis / Schroeven

**M 1:1**

A = 2,2 x 7	B = 2,2 x 10	C = 3,0 x 10	D = 3,0 x 14

Aufnahmefach für Reedkontakt  
 Reed Switch Cover  
 Caisse platine Contact reed  
 Reedcontactprint

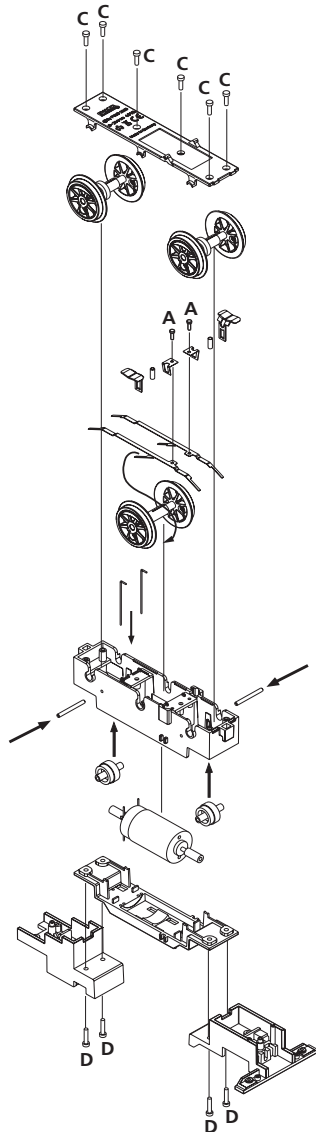

36143

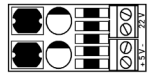

Dampfgenerator #36142 ist nur in Verbindung mit dem Festspannungsregler #36143 zu verwenden.  
 #36142 smoke generator is to be used only with the voltage regulator #36143

36141/36142  
 Dampfgenerator  
 Smoke Generator  
 nicht enthalten/not included

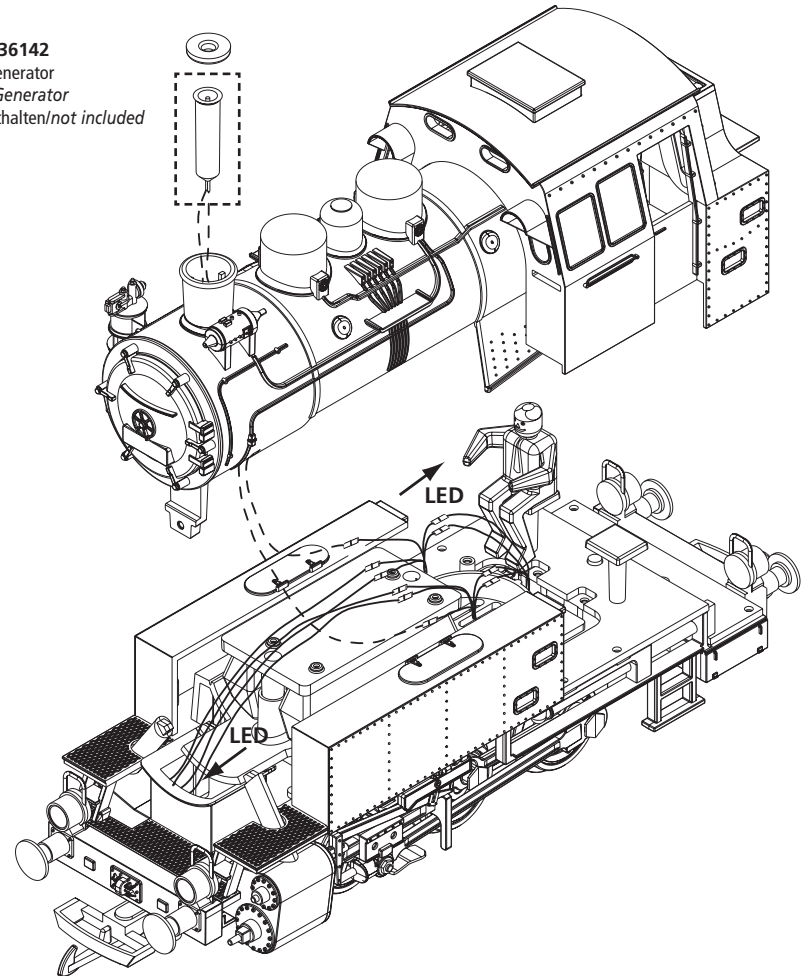



Fetten  
Grease  
Graisse  
Smeren

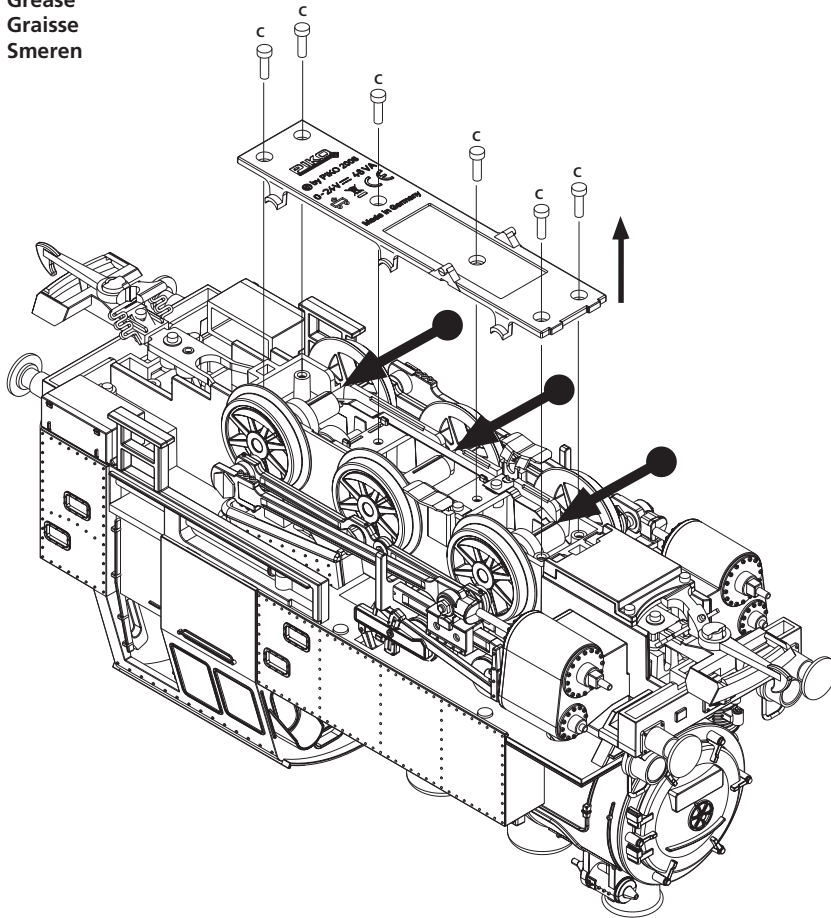

## VERDRAHTUNGSSCHEMA

Wiring scheme · Schema de câblage · Bedradingsschema

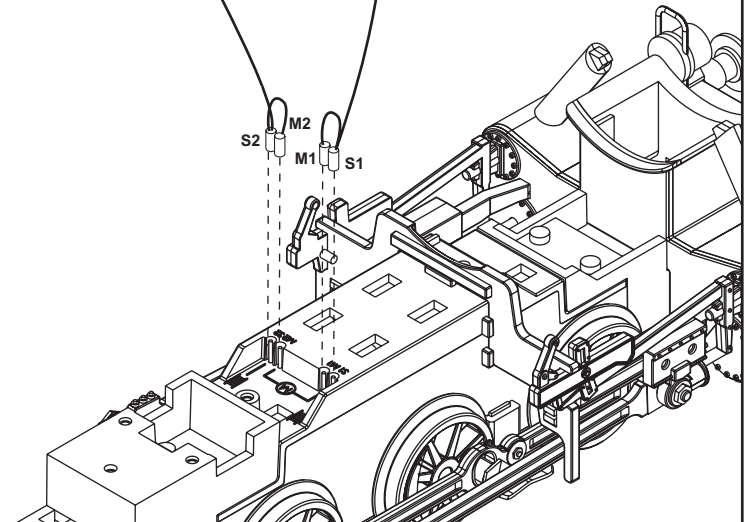
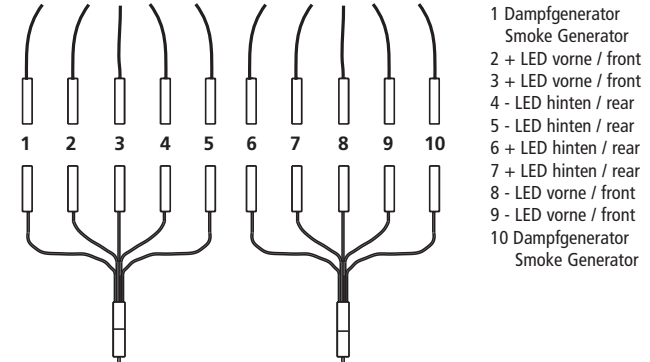

# ERSATZTEILE BR 80

Spare parts · Pièces détachées · Reserveonderdelen

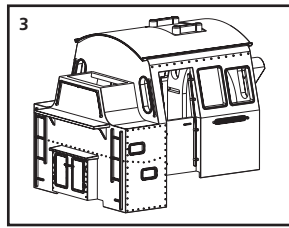
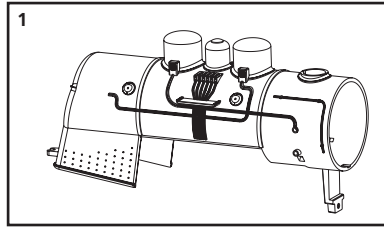

Bei Ersatzteilanforderung bitte immer die vollständige Ersatzteil-Nr. angeben. · Please order the wanted spare part with the complete spare part item number. · Lorsque vous commandez une pièce, veuillez bien nous donner la référence complète de la pièce. Bij bestelling van een reserveonderdeel svp altijd het volledige onderdeelnummer opgeven.

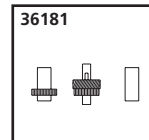
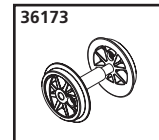
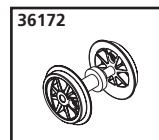
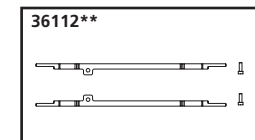
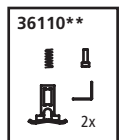
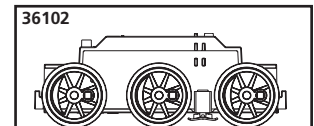
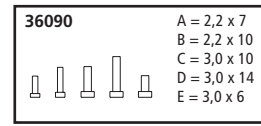
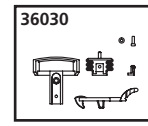
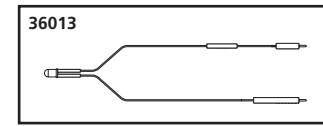
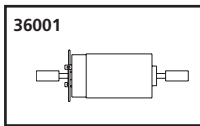
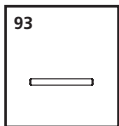
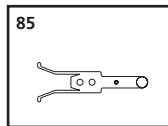
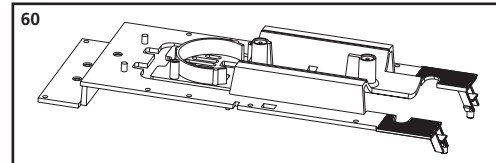
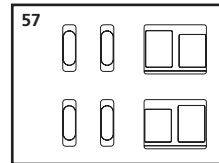
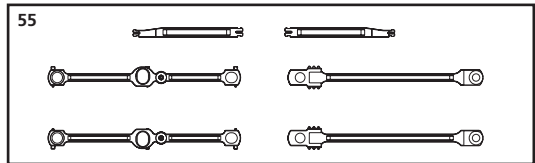
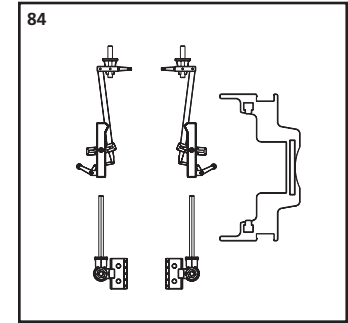
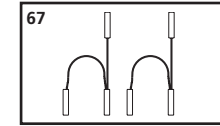
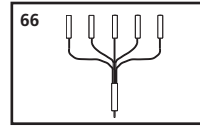
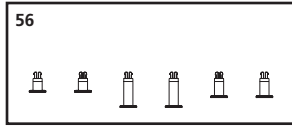
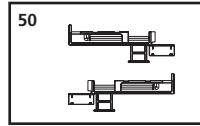
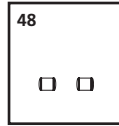
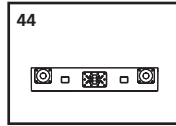
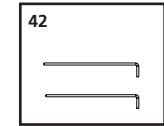
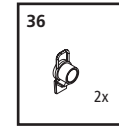
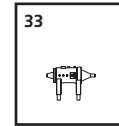
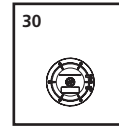
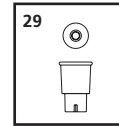
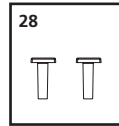
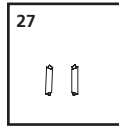
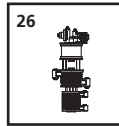
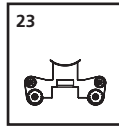
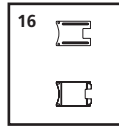
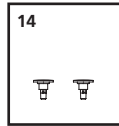
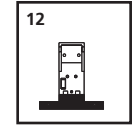
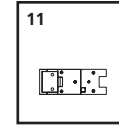
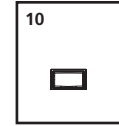
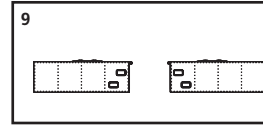
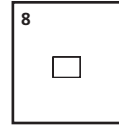

# ERSATZTEILLISTE BR 80

Spare parts · Pièces détachées · Reserveonderdelen

Nr.	Bezeichnung:	Description:	Désignation:	Beschrijving:	PG*
37100A-01	Kessel	Boiler	Chaudière	Ketel	10
37100A-03	Führerhaus	Cab with Fuel Bunker	Cabine	Machinistenhuis	11
37100A-08	Dachabdeckung	Roof Hatch Cover	Clapet de toit	Ontluchtingsluik	6
37100A-09	Wasserkästen	Water Tanks	Réservoir à eau	Waterkasten	12
37100A-10	Kohleaufsatz	Coal Insert	Charbon	Kolenbak	6
37100A-11	Rahmenhinterteil	Rear Sub-Frame	Partie arrière du chassis	Chassisdeel achterzijde	8
37100A-12	Rahmenvorderteil	Front Sub-Frame	Partie avant du chassis	Chassisdeel voorzijde	9
37500-14	Puffer (2 St.)	Buffers, 2Pcs	Tampons (2 unités)	Buffer (2 stuks)	6
37100A-16	Gehäuse Reedkontaktplatine	Reed Switch Housing	Caisse platine contact reed	Behuizing voor de Reedcontactprint	8
37410-42	Winkelkontakte Antriebseinheit (2-tlg.)	Gearbox Contact Posts, 2 Pcs	Equerres pour fixation moteur (2 pièces)	Hoekcontacten aandrijfkast (2-delig)	5
37100A-23	Zylinder	Cylinder Saddle	Cylindre	Cylinder	9
37100A-26	Luftpumpe	Air Pump	Pompe à air	Luchtpomp	7
37100A-27	Dampfrohr (2 St.)	Steam Pipe, 2 Pcs	Tuyaux vapeur x 2	Stoomleiding (2 st.)	7
37100A-28	Sitz (2 St.)	Seat, 2 Pcs	Siège (2 unités)	Machinistenstoel (2 stuks)	8
37100A-29	Schlot + Schutzkappe	Smokestack and Safety Funnel	Cheminée et clapet	Schoorsteen + afdekplaat	7
37100A-30	Rauchkammertür	Smokebox Front	Porte de boîte à fumée	Rookkastdeur	9
37100A-33	Lichtmaschine	Turbo Generator	Appareil lumineux	Dynamo	6
37100A-36	Laterne mit Linse (2 St.)	Lantern with Linse, 2 Pcs	Phares (x2)	Lantaarns met glas (2 stuks)	10
37100A-44	Pufferbohle (für 2 Puffer)	End Beam for 2 Buffers	Traverse de tamponnement + 2 tampons	Bufferbalk met 2 buffers	9
37100A-48	Luftkessel (2 Stück)	Air Cylinder, 2 Pcs	Citernes à air x 2	Luchtketel (2 st.)	7
37100A-50	Rahmenseiteile (2-tlg.)	Cab Floor Side Frame, L & R	Parties latérales du chassis x 2	Chassis zijdelen (2-delig)	9
37100A-55	Steuerung 1	Side Rods	Embiellage 1	Drijfwerk 1	10
37100A-56	Kurbelbolzen (6-tlg.)	Crankpin Screws (Set of 6)	Boulon de manivelle (6 unités)	Bouten (6-delig)	9
37100A-57	Satz Fenster	Window Inserts (Set of 6)	Fenêtres	Venster	10
37100A-60	Bodenplatte	Main Frame	Support	Bodemplaat	11
37100A-84	Steuerung 2	Valve Gear	Embiellage 2	Drijfwerk 2	10
37100A-85	Kupplungsarm	Coupler Arm	Attelage	Koppelarm	6
37100A-66	Verteilerkabel	Wiring Harness	Câble de répartition	Verdeekabel	7
37100A-67	Motorkabel (2 St.)	Cables (Set of 2)	Câble (2 unités)	Motorkabel (2 st.)	9
37320-93	Zahnradwelle	Idler Gear shaft	Lame	Tandwielas	7
	<b>Standard Ersatzteile</b>	<b>Catalog Parts</b>	<b>Pièces détachées standard</b>	<b>Standaardonderdelen</b>	
36001	Motor mit Schnecken	Motor w/ Gears	Moteur avec mandrin	Motor met wormwiel	
36013	LED Beleuchtung	LED Lighting	Led	LEDs	
36030	Kupplung komplett	Standard Loco Coupler	Attelage, complet	Koppeling, volledig	
36090	Schrauben-Set (20-tlg./5 Größen)	Set of screws (20 pieces / 5 sizes)	Jeu de vis	Set schroeven	
36102	Antriebseinheit komplett	Gearbox, complete	Engrenage, complet	Aandrijving, compleet	
36110**	Schienenfleifer (2 Sets)	Pick-Up Shoes, 2 Pieces	Contact de rails (2 unités)	Railsleepcontact (2 sets)	
36112**	Radsatzkontakt re. + li.	Wheel Wipers, R & L	Contacts d'essieux (droit & gauche)	Wielcontact rechts en links	
36172	Radsatz mit Zahnrad	Wheelset with Gear	Essieux avec pignon	Wielstel met tandwiel	
36173	Radsatz ohne Zahnrad	Wheelset without Gear	Essieux	Wielstel	
36181	Zahnradset	Gear Set	Roues dentées	Tandwielset	
36200	Lokführer bemalt	Engineer Figure	Conducteur de locomotive	Machinistenfiguur	

\* Preisgruppe · price category · catégorie de prix · Priscategorie

\*\* Verschleißteil · Wearing part · Pièce de fatigue

# ZUBEHÖR BR 80

Accessories · Accessoires

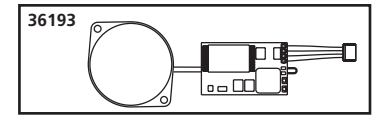
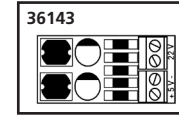
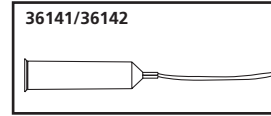
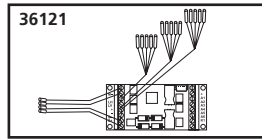
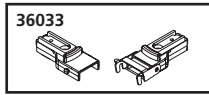
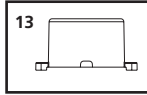
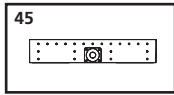

Nr:	Zubehör	Optional Add-Ons	Accessoires	Accessoires	PG*
36033	Ganzzug-Kupplung	Rigid Coupler	Coupler rigide	Starre koppeling	
36121	Umbauset Digital inkl. Decoder	Decoder Kit	Décodeur	Digitale ombouwset incl. decoder	
36141	Dampfgenerator digital	Smoke Generator for Digital	Générateur de fumée, digital	Rookgenerator digitaal	
36142	Dampfgenerator 5 V	Smoke Unit, 5 V	Générateur de fumée, 5 V	Rookgenerator 5 V	
36143	Festspannungsregler 5 V	Voltage Regulator 5 V	Régulateur de tension 5 V	Spanningsregelaar 5 V	
36193	Dampflokom-Sound-Modul mit Lautsprecher	Sound Unit BR 80 (Digital Only) (Requires decoder 36121)	Module de son avec haut parleur étanche	Soundmodule met luidspreker	
38100A-13	Schallkapsel für Lautsprecher	Speaker Enclosure	Caisse de résonance pour haut parleur	Geluidskast voor luidspreker	6
37100A-45	Pufferbohle (für Mittelpuffer)	End Beam for Single Buffer	Traverse de tamponnement + tampon central	Bufferbalk met middenbuffer	9

# ERSATZTEILE SCHÜTTGUTWAGEN OOt 96

Spare parts Ore Car · Pièces détachées Wagon à charbon · Reserveonderdelen Zelflosser

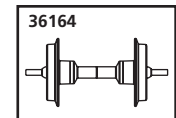
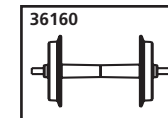
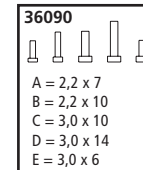
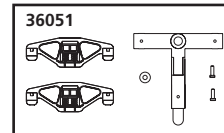
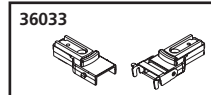
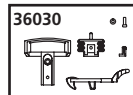
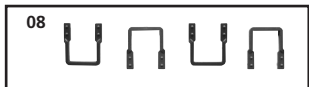

Nr:	Bezeichnung:	Description:	Désignation:	Beschrijving:	PG*
37800-08	Trittstufen (4 St.)	Stirrup Steps, 4 Pcs	Marche pieds (4 unités)	Trede (4 stuks)	8
	<b>Standard Ersatzteile</b>	<b>Spare parts, standard range</b>	<b>Pièces détachées standard</b>	<b>Standaardonderdelen</b>	
36030	Kupplung komplett	Standard Coupler	Attelage, complet	Koppeling, volledig	
36033	Ganzzug-Kupplung	Rigid Coupler	Coupler rigide	Starre koppeling	
36051	Drehgestell „Bettendorf“	Bettendorf Truck	Bogie	Draaistel	
36090	Schrauben-Set (20-tlg./5 Größen)	Screws (5 Sizes, 20 Pcs)	Jeu de vis (20 pièces, 5 tailles)	Set schroeven (20-delig)	
36160	Radsatz Kunststoff (2 St.)	Plastic Wheelset (set of 2)	Essieux plastiques (2 unités)	Kunststof wielstel (2-delig)	
36164	Radsatz Metall (2 St.)	Metal Wheelset (set of 2)	Essieux métalliques (2 unités)	Metalen wielstel (2-delig)	

\*Preisgruppe \*price category \*catégorie de prix \*Priscategorie

PIKO Spielwaren GmbH · Lutherstraße 30 · 96515 Sonneberg